

LM4701 Overture™ Audio Power Amplifier Series

30W Audio Power Amplifier with Mute and Standby Modes

General Description

The LM4701 is an audio power amplifier capable of delivering typically 30W of continuous average output power into an 8Ω load with less than 0.1% THD+N.

The LM4701 has an independent smooth transition fade-in/out mute and a power conserving standby mode which can be controlled by external logic.

The performance of the LM4701, utilizing its Self Peak Instantaneous Temperature (°Ke) (**SPIke™**) protection circuitry, places it in a class above discrete and hybrid amplifiers by providing an inherently, dynamically protected Safe Operating Area (SOA). **SPIke** protection means that these parts are completely safeguarded at the output against overvoltage, undervoltage, overloads, including thermal runaway and instantaneous temperature peaks.

Key Specifications

- THD+N at 1kHz at continuous average output power of 25W into 8Ω: 0.1% (max)
- THD+N from 20Hz to 20kHz at 30W of continuous average output power into 8Ω: 0.08% (typ)
- Standby current: 2.1mA (typ)

Features

- **SPIke** Protection
- Minimal amount of external components necessary
- Quiet fade-in/out mute function
- Power conserving standby-mode
- Non-Isolated 9-lead TO-220 package
- Wide supply range 20V - 66V

Applications

- TVs
- Component stereo
- Compact stereo

Typical Application

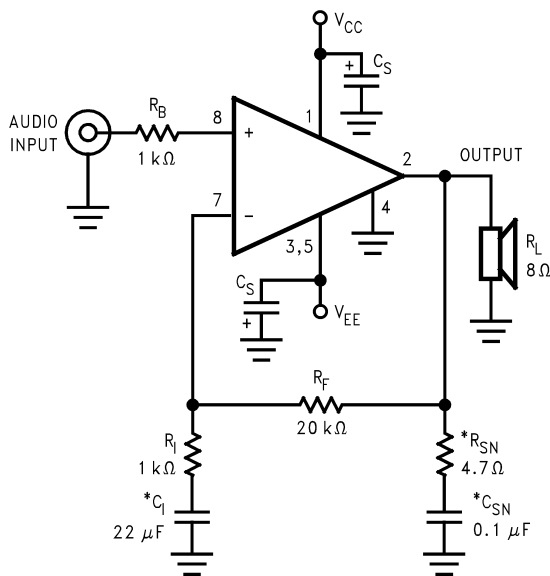

10083501

*Optional components dependent upon specific design requirements. Refer to the External Components Description section for a component functional description.

FIGURE 1. Typical Audio Amplifier Application Circuit

Connection Diagram

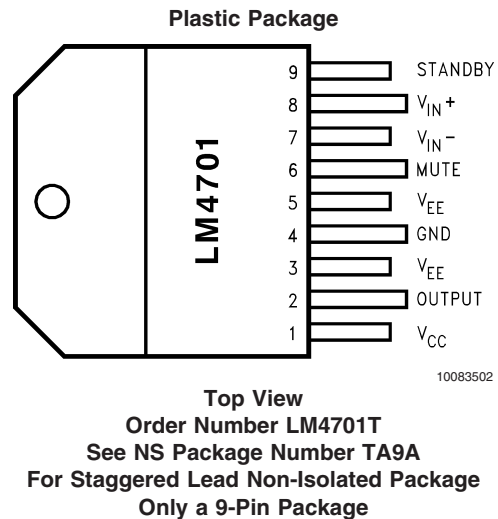

Absolute Maximum Ratings (Notes 5,

4)

If Military/Aerospace specified devices are required, please contact the National Semiconductor Sales Office/Distributors for availability and specifications.

Supply Voltage $ V_{CC} + V_{EE} $ (No Signal)	66V
Supply Voltage $ V_{CC} + V_{EE} $ (with Input and Load)	64V
Common Mode Input Voltage	$(V_{CC} \text{ or } V_{EE}) \text{ and } V_{CC} + V_{EE} \leq 60V$
Differential Input Voltage	60V
Output Current	Internally Limited
Power Dissipation (Note 6)	62.5W
ESD Susceptibility (Note 7)	2000V

Junction Temperature (Note 8)	150°C
Thermal Resistance	
θ_{JC}	1.8°C/W
θ_{JA}	43°C/W
Soldering Information	
TF Package (10 sec.)	260°C
Storage Temperature	$-40^\circ\text{C} \leq T_A \leq +150^\circ\text{C}$

Operating Ratings (Notes 4, 5)

Temperature Range	
$T_{MIN} \leq T_A \leq T_{MAX}$	$-20^\circ\text{C} \leq T_A \leq +85^\circ\text{C}$
Supply Voltage $ V_{CC} + V_{EE} $ (Note 1)	20V to 64V

Electrical Characteristics

(Notes 4, 5) The following specifications are for $V_{CC} = +28V$, $V_{EE} = -28V$ with $R_L = 8\Omega$, unless otherwise specified. Limits apply for $T_A = 25^\circ\text{C}$.

Symbol	Parameter	Conditions	LM4701		Units (Limits)
			Typical (Note 9)	Limit (Note 10)	
$ V_{CC} + V_{EE} $	Power Supply Voltage (Note 11)	$GND - V_{EE} \geq 9V$	18	20	V (min)
				64	V (max)
P_O (Note 3)	Output Power (Continuous Average)	THD + N = 0.1% (max), $f = 1 \text{ kHz}$ $R_L = 8\Omega$, $ V_{CC} = V_{EE} = 28V$	30	25	W/ch (min)
		$R_L = 4\Omega$, $ V_{CC} = V_{EE} = 20V$ (Note 13)	22	15	W/ch (min)
THD + N	Total Harmonic Distortion Plus Noise	30W/ch, $R_L = 8\Omega$, 20 Hz $\leq f \leq 20 \text{ kHz}$, $A_V = 26 \text{ dB}$	0.08		%
SR (Note 3)	Slew Rate	$V_{IN} = 1.414 V_{rms}$, $t_{rise} = 2 \text{ ns}$	18	12	V/ μs (min)
I_{TOTAL} (Note 2)	Total Quiescent Power Supply Current	$V_{CM} = 0V$, $V_O = 0V$, $I_O = 0 \text{ mA}$ Standby: Off	25	40	mA (max)
		Standby: On	2.1		mA
Standby Pin V_{IL}	Standby Low Input Voltage	Not in Standby Mode		0.8	V (max)
		In Standby Mode	2.0	2.5	V (min)
Mute Pin V_{IL}	Mute Low Input Voltage	Output Not Muted		0.8	V (max)
		Output Muted	2.0	2.5	V (min)
A_M	Mute Attenuation	$V_{PIN8} = 2.5V$	115	80	dB (min)
V_{OS} (Note 2)	Input Offset Voltage	$V_{CM} = 0V$, $I_O = 0 \text{ mA}$	2.0	15	mV (max)
I_B	Input Bias Current	$V_{CM} = 0V$, $I_O = 0 \text{ mA}$	0.2	0.5	μA (max)
I_{OS}	Input Offset Current	$V_{CM} = 0V$, $I_O = 0 \text{ mA}$	0.002	0.2	μA (max)
I_O	Output Current Limit	$ V_{CC} = V_{EE} = 10V$, $t_{ON} = 10 \text{ ms}$, $V_O = 0V$	3.5	2.9	A_{PK} (min)
V_{OD} (Note 2)	Output Dropout Voltage (Note 12)	$ V_{CC} - V_O $, $V_{CC} = 20V$, $I_O = +100 \text{ mA}$	1.8	2.3	V (max)
		$ V_O - V_{EE} $, $V_{EE} = -20V$, $I_O = -100 \text{ mA}$	2.5	3.2	V (max)

Electrical Characteristics (Continued)

(Notes 4, 5) The following specifications are for $V_{CC} = +28V$, $V_{EE} = -28V$ with $R_L = 8\Omega$, unless otherwise specified. Limits apply for $T_A = 25^\circ C$.

Symbol	Parameter	Conditions	LM4701		Units (Limits)
			Typical (Note 9)	Limit (Note 10)	
PSRR (Note 2)	Power Supply Rejection Ratio	$V_{CC} = 30V$ to $10V$, $V_{EE} = -30V$, $V_{CM} = 0V$, $I_O = 0$ mA	115	85	dB (min)
		$V_{CC} = 30V$, $V_{EE} = -30V$ to $-10V$ $V_{CM} = 0V$, $I_O = 0$ mA	110	85	dB (min)
CMRR (Note 2)	Common Mode Rejection Ratio	$V_{CC} = 35V$ to $10V$, $V_{EE} = -10V$ to $-35V$, $V_{CM} = 10V$ to $-10V$, $I_O = 0$ mA	110	80	dB (min)
A_{VOL} (Note 2)	Open Loop Voltage Gain	$R_L = 2$ k Ω , $\Delta V_O = 30V$	110	90	dB (min)
GBWP	Gain-Bandwidth Product	$f_O = 100$ kHz, $V_{IN} = 50$ mVrms	7.5	5	MHz (min)
e_{IN} (Note 3)	Input Noise	IHF—A Weighting Filter $R_{IN} = 600\Omega$ (Input Referred)	2.0	8	μV (max)
SNR	Signal-to-Noise Ratio	$P_O = 1W$, A-Weighted, Measured at 1 kHz, $R_S = 25\Omega$	98		dB
		$P_O = 25W$, A-Weighted Measured at 1 kHz, $R_S = 25\Omega$	108		dB

Note 1: Operation is guaranteed up to 64V, however, distortion may be introduced from **SPiKe** Protection Circuitry if proper thermal considerations are not taken into account. Refer to the **Application Information** section for a complete explanation.

Note 2: DC Electrical Test; Refer to Test Circuit #1.

Note 3: AC Electrical Test; Refer to Test Circuit #2.

Note 4: All voltages are measured with respect to the GND (pin 7), unless otherwise specified.

Note 5: Absolute Maximum Ratings indicate limits beyond which damage to the device may occur. Operating Ratings indicate conditions for which the device is functional, but do not guarantee specific performance limits. Electrical Characteristics state DC and AC electrical specifications under particular test conditions which guarantee specific performance limits. This assumes that the device is within the Operating Ratings. Specifications are not guaranteed for parameters where no limit is given, however, the typical value is a good indication of device performance.

Note 6: For operating at case temperatures above $25^\circ C$, the device must be derated based on a $150^\circ C$ maximum junction temperature and a thermal resistance of $\theta_{JC} = 1.8$ $^\circ C/W$ (junction to case). Refer to the section, Determining the Correct Heat Sink, in the Application Information section.

Note 7: Human body model, 100 pF discharged through a 1.5 k Ω resistor.

Note 8: The operating junction temperature maximum is $150^\circ C$, however, the instantaneous Safe Operating Area temperature is $250^\circ C$.

Note 9: Typical values are measured at $25^\circ C$ and represent the parametric norm.

Note 10: Limits are guaranteed that all parts are tested in production to meet the stated values.

Note 11: V_{EE} must have at least $-9V$ at its pin with reference to ground in order for the under-voltage protection circuitry to be disabled. In addition, the voltage differential between V_{CC} and V_{EE} must be greater than 14V.

Note 12: The output dropout voltage, V_{OD} , is the supply voltage minus the clipping voltage. Refer to the Clipping Voltage vs. Supply Voltage graph in the Typical Performance Characteristics section.

Note 13: For a 4 Ω load, and with $\pm 20V$ supplies, the LM4701 can deliver typically 22 Watts of continuous average power per channel with less than 0.1% (THD+N). With supplies above $\pm 20V$, the LM4701 cannot deliver more than 22 watts into 4 Ω due to current limiting of the output transistors. Thus, increasing the power supply above $\pm 20V$ will only increase the internal power dissipation, not the possible output power. Increased power dissipation will require a larger heat sink as explained in the Application Information section.

Test Circuit #1 (Note 2) (DC Electrical Test Circuit)

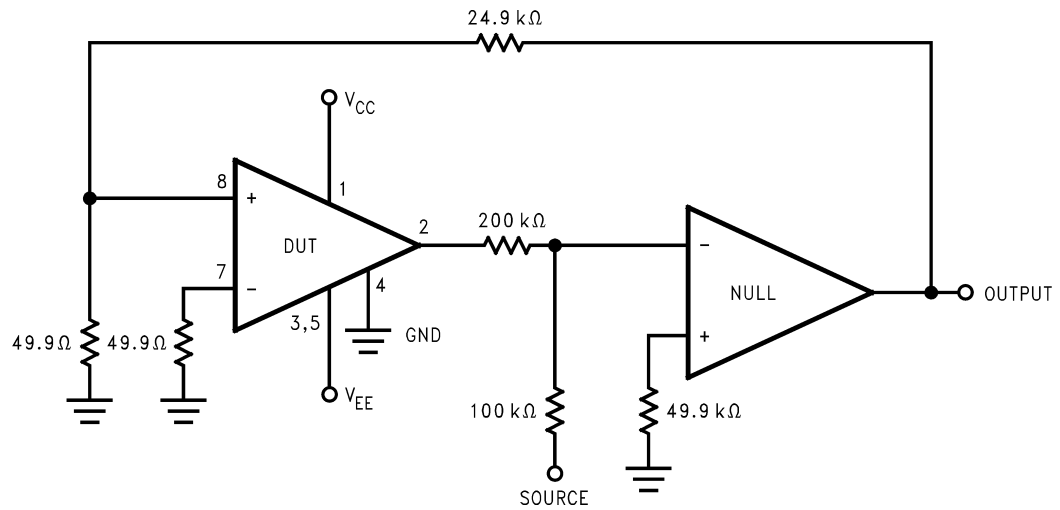

10083503

Test Circuit #2 (Note 3) (AC Electrical Test Circuit)

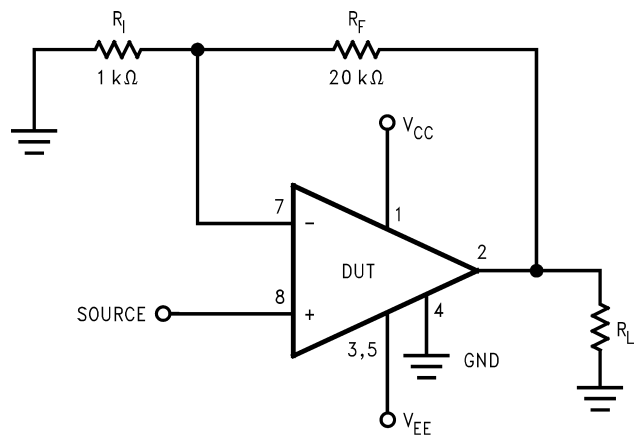

10083504

Bridged Amplifier Application Circuit

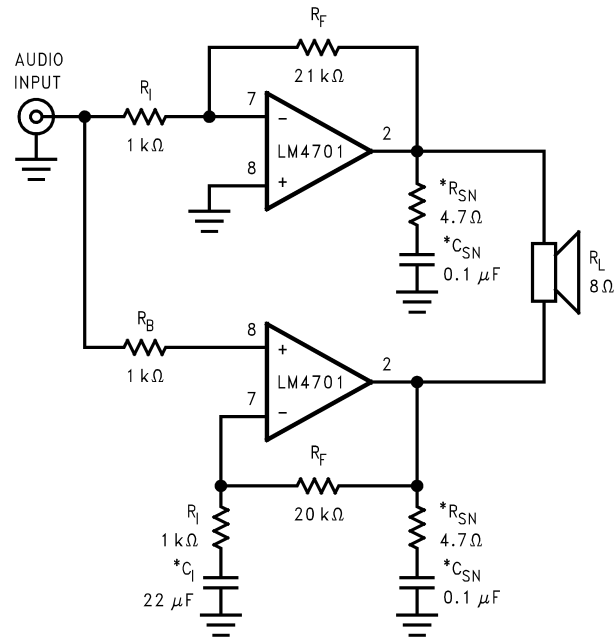

10083505

FIGURE 2. Bridged Amplifier Application Circuit

Single Supply Application Circuit

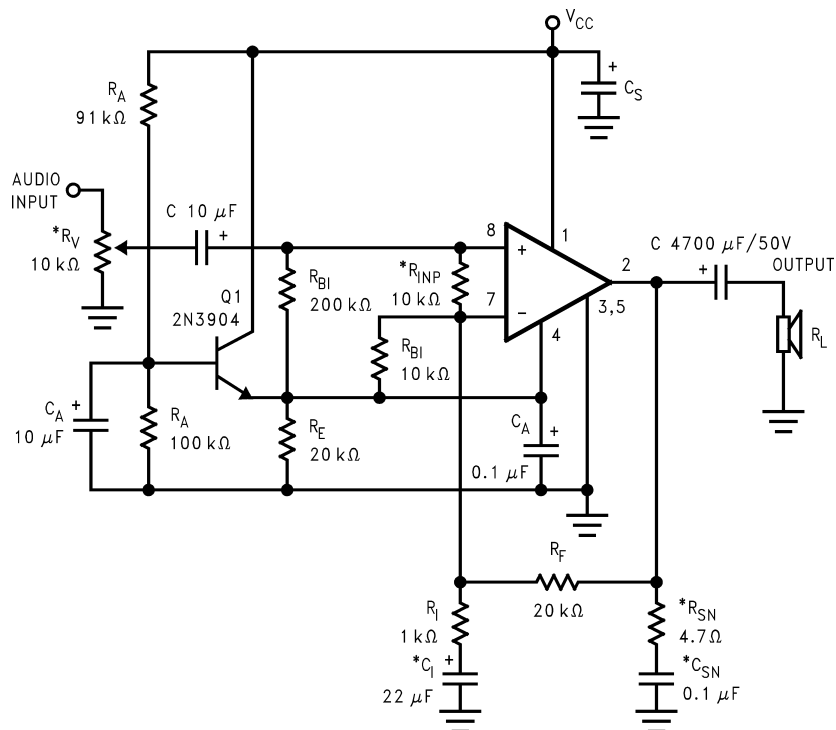

10083506

FIGURE 3. Single Supply Amplifier Application Circuit

Auxillary Amplifier Application Circuit

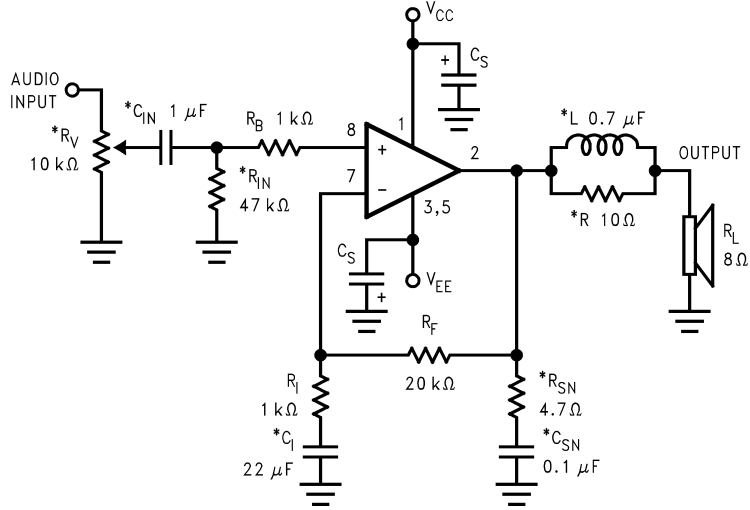

10083507

FIGURE 4. Auxillary Amplifier Application Circuit

Equivalent Schematic (Excluding Active Protection Circuitry)

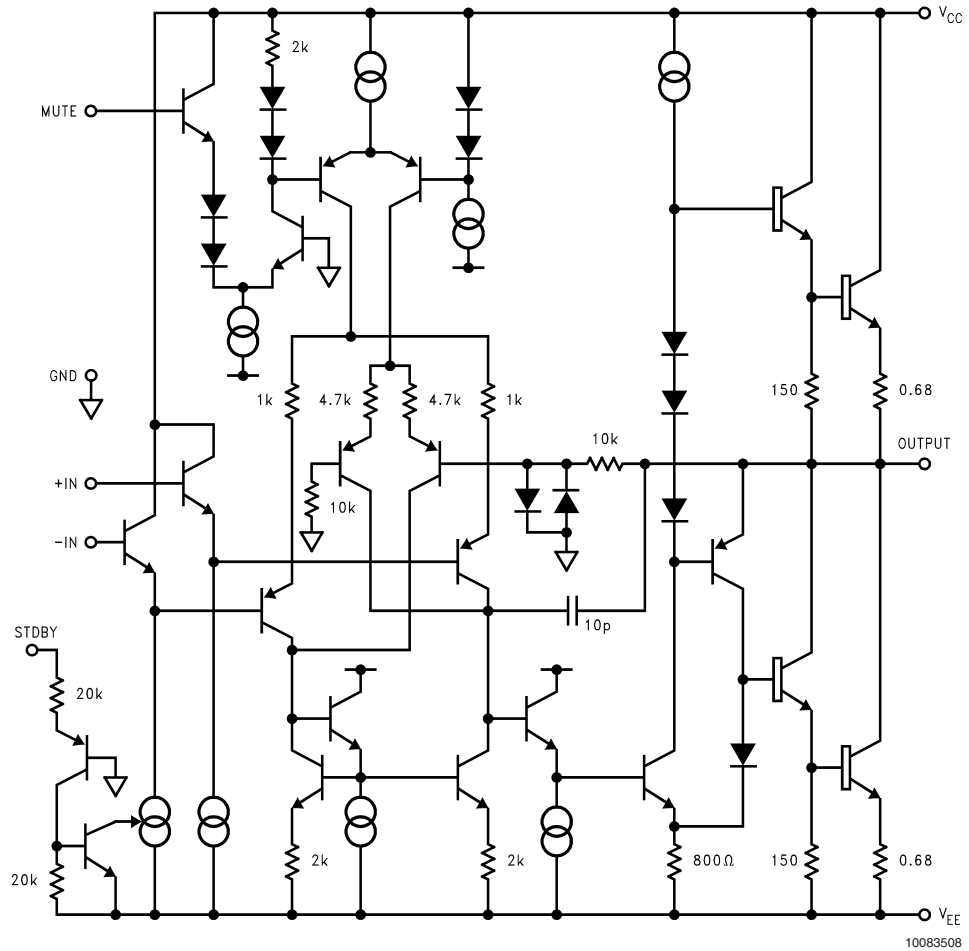

10083508

External Components Description

Components		Functional Description
1	R_B	Prevents currents from entering the amplifier's non-inverting input which may be passed through to the load upon power down of the system due to the low input impedance of the circuitry when the undervoltage circuitry is off. This phenomenon occurs when the supply voltages are below 1.5V.
2	R_I	Inverting input resistance to provide AC gain in conjunction with R_F . Also creates a highpass filter with C_I at $f_C = 1/(2\pi R_I C_I)$.
3	R_F	Feedback resistance to provide AC gain in conjunction with R_I .
4	C_I (Note 14)	Feedback capacitor which ensures unity gain at DC.
5	C_S	Provides power supply filtering and bypassing. Refer to the Supply Bypassing application section for proper placement and selection of bypass capacitors.
6	R_V (Note 14)	Acts as a volume control by setting the input voltage level.
7	R_{IN} (Note 14)	Sets the amplifier's input terminals DC bias point when C_{IN} is present in the circuit. Also works with C_{IN} to create a highpass filter at $f_C = 1/(2\pi R_{IN} C_{IN})$. Refer to <i>Figure 4</i> .
8	C_{IN} (Note 14)	Input capacitor which blocks the input signal's DC offsets from being passed onto the amplifier's inputs.
9	R_{SN} (Note 14)	Works with C_{SN} to stabilize the output stage by creating a pole that reduces high frequency instabilities. The pole is set at $f_C = 1/(2\pi R_{SN} C_{SN})$. Refer to <i>Figure 4</i> .
10	C_{SN} (Note 14)	Works with R_{SN} to stabilize the output stage by creating a pole that reduces high frequency instabilities.
11	L (Note 14)	Provides high impedance at high frequencies so that R may decouple a highly capacitive load and reduce the Q of the series resonant circuit. Also provides a low impedance at low frequencies to short out R and pass audio signals to the load. Refer to <i>Figure 4</i> .
12	R (Note 14)	
13	R_A	Provides DC voltage biasing for the transistor Q1 in single supply operation.
14	C_A	Provides bias filtering for single supply operation.
15	R_{INP} (Note 14)	Limits the voltage difference between the amplifier's inputs for single supply operation. Refer to the Clicks and Pops application section for a more detailed explanation of the function of R_{INP} .
16	R_{BI}	Provides input bias current for single supply operation. Refer to the Clicks and Pops application section for a more detailed explanation of the function of R_{BI} .
17	R_E	Establishes a fixed DC current for the transistor Q1 in single supply operation. This resistor stabilizes the half-supply point along with C_A .

Note 14: Optional components dependent upon specific design requirements.

Typical Performance Characteristics

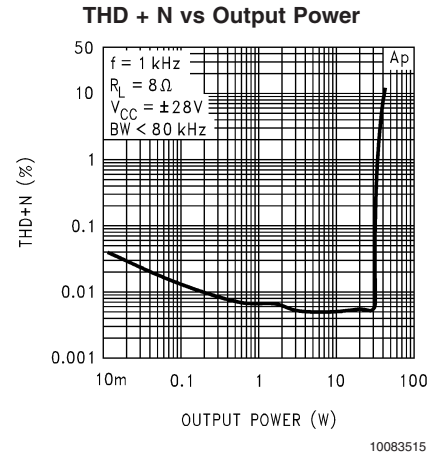
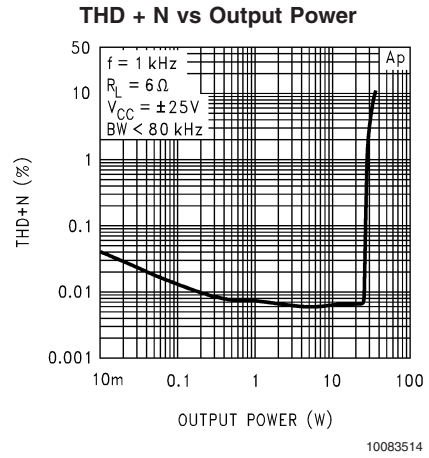
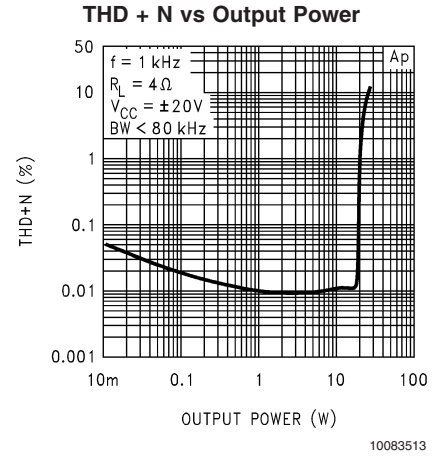
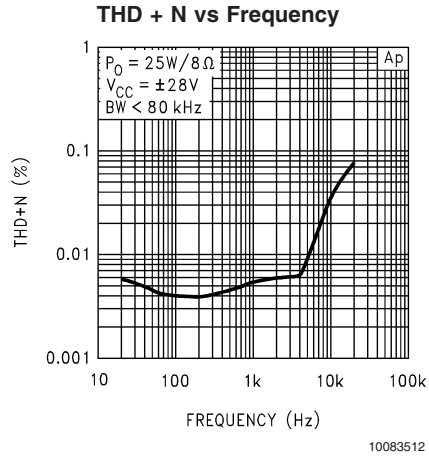
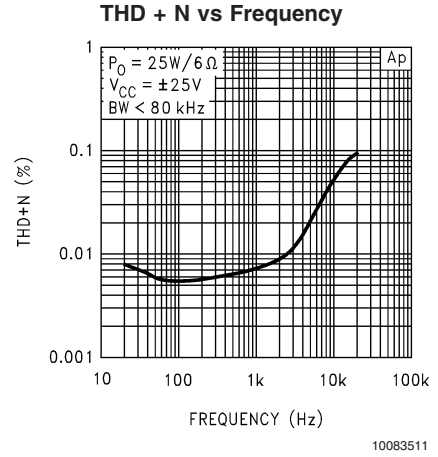
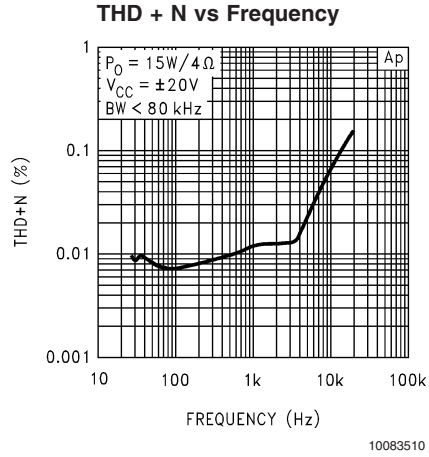

Typical Performance Characteristics (Continued)

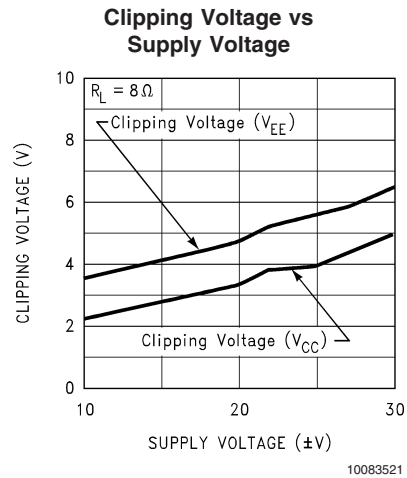
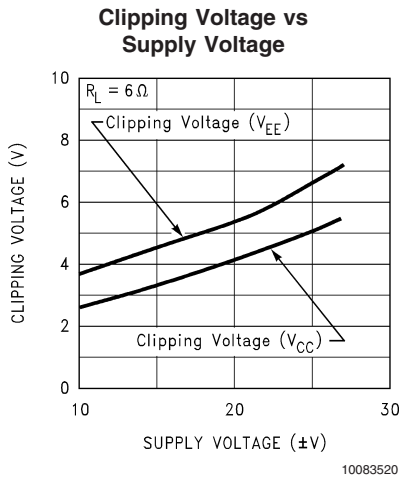
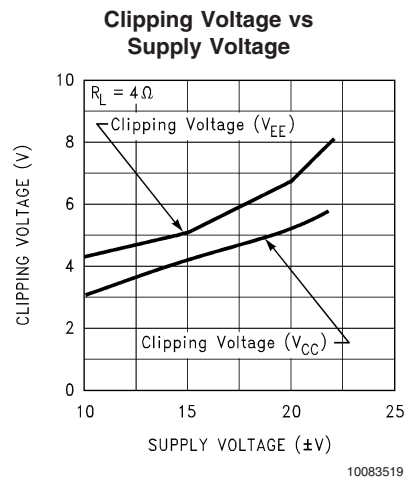
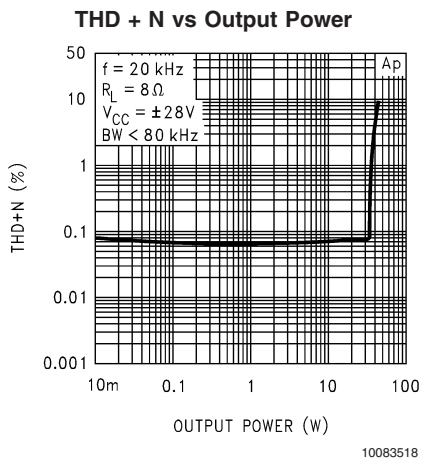
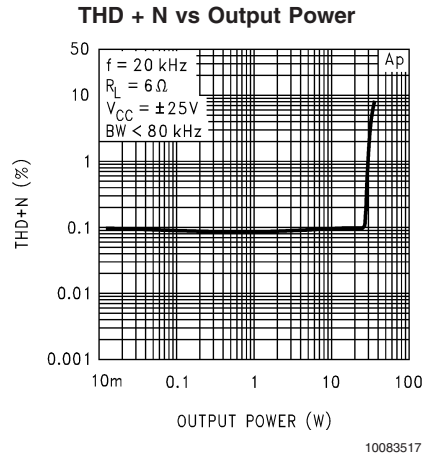
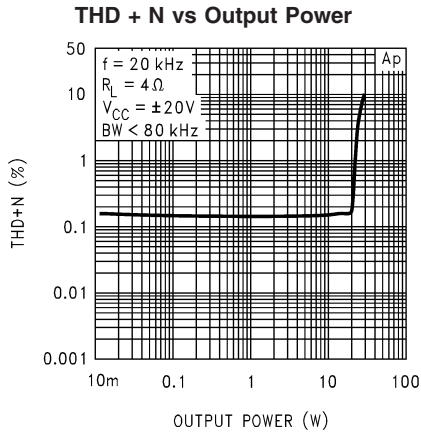

Typical Performance Characteristics (Continued)

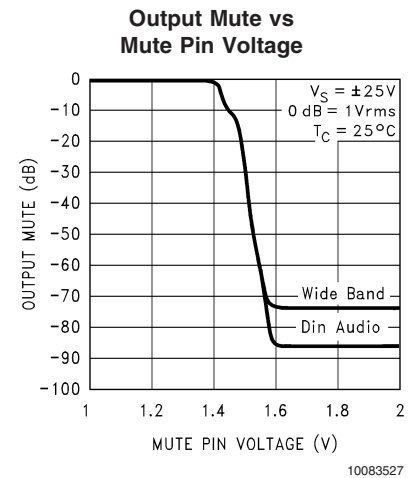
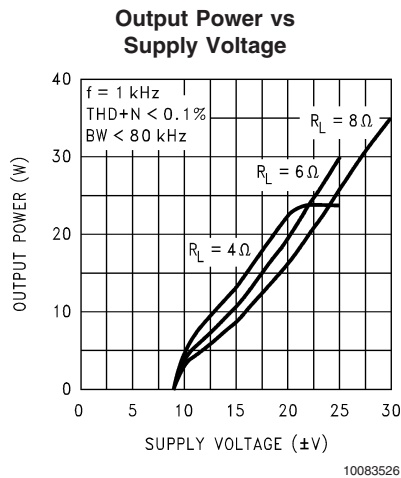
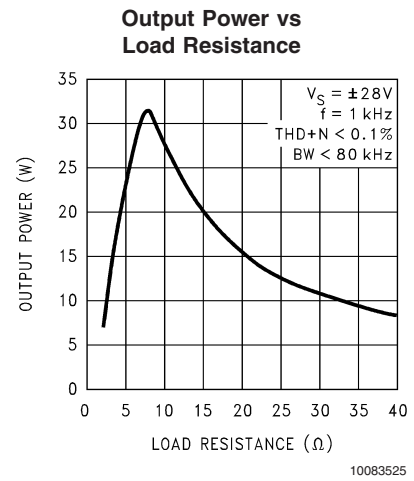
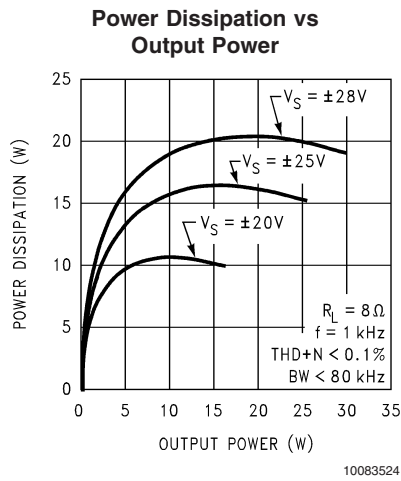
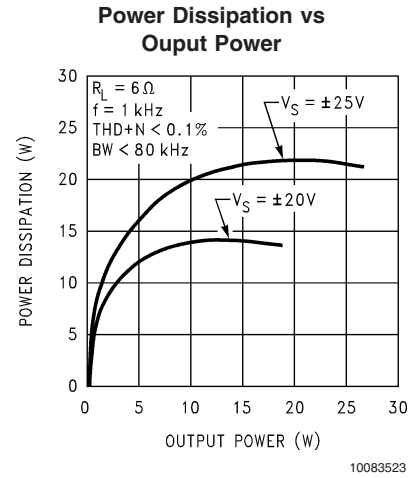
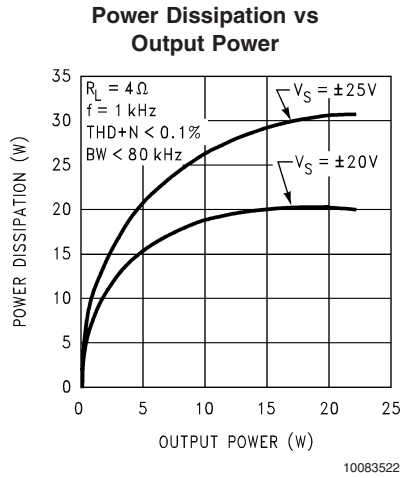

Typical Performance Characteristics (Continued)

Pulse Response

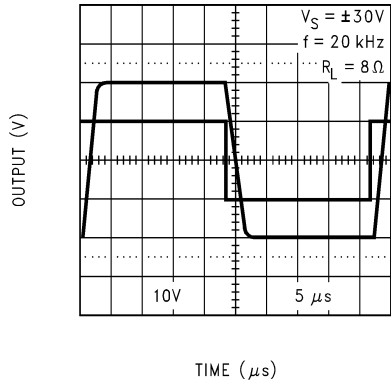

10083528

Large Signal Response

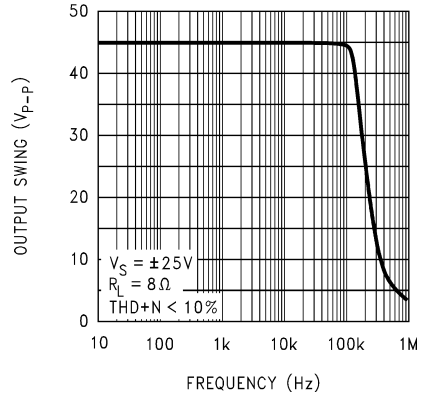

10083529

Output Mute vs Mute Pin Voltage

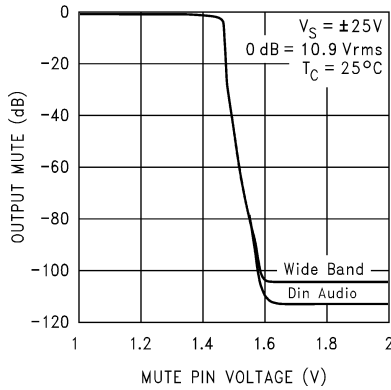

10083530

Power Supply Rejection Ratio

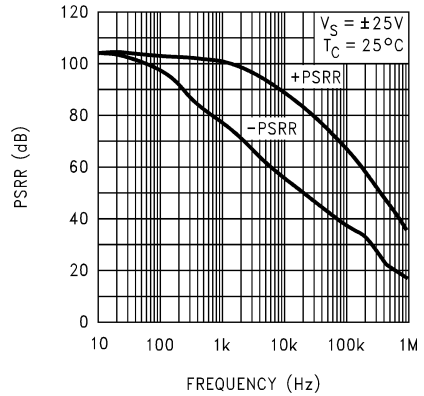

10083531

Common-Mode Rejection Ratio

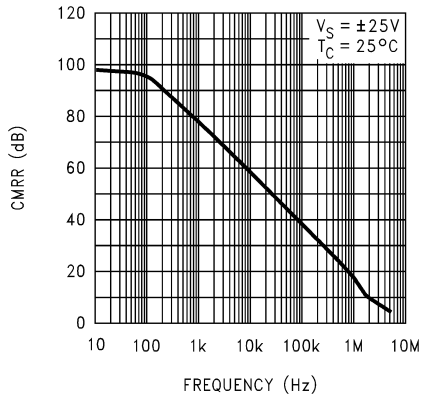

10083532

Open Loop Frequency Response

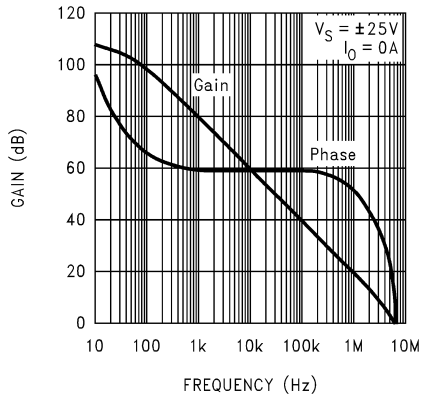

10083533

Typical Performance Characteristics (Continued)

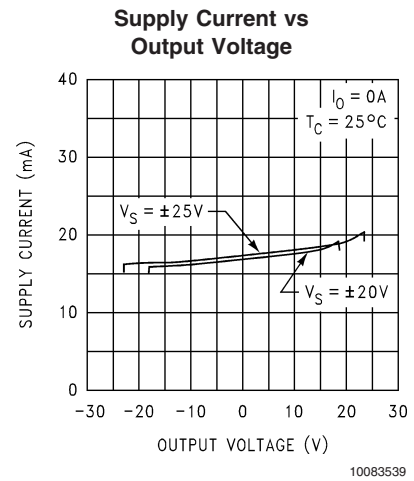
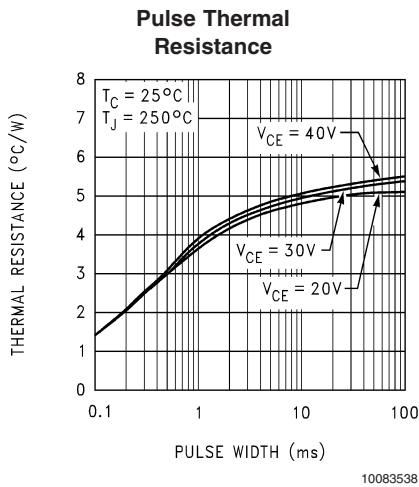
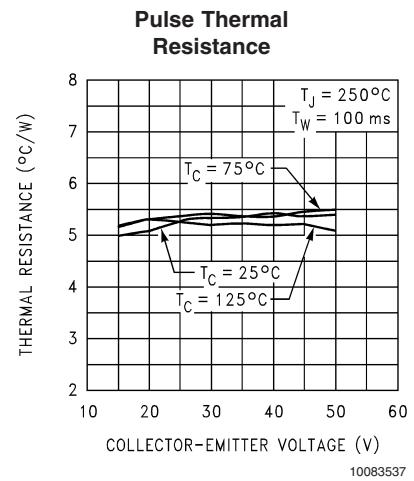
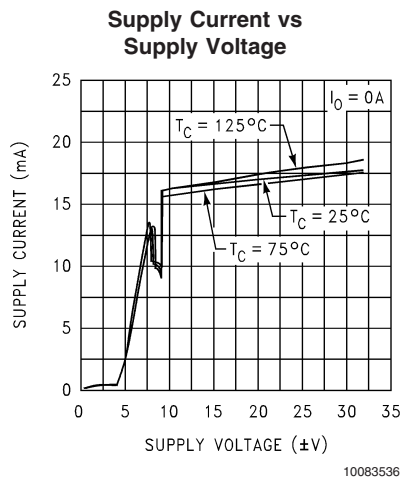
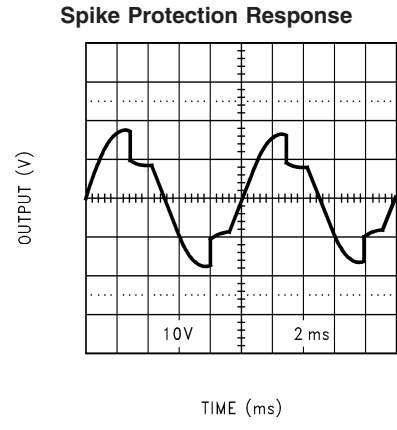
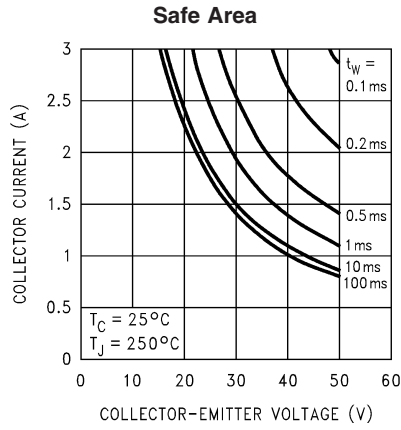

Typical Performance Characteristics (Continued)

Pulse Power Limit

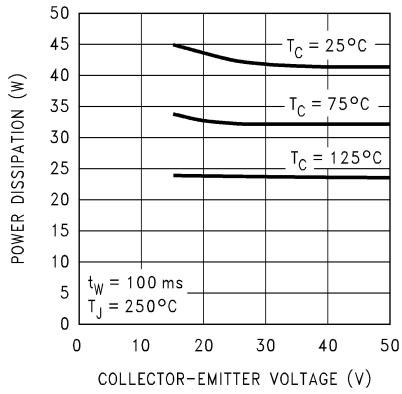

10083540

Pulse Power Limit

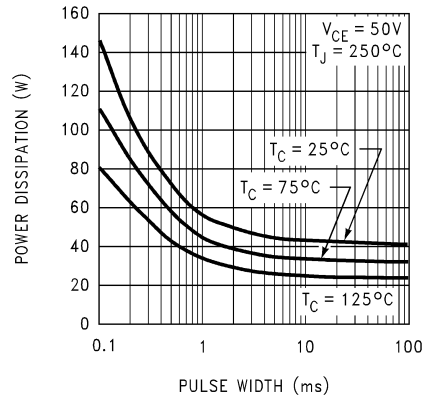

10083541

Supply Current vs Case Temperature

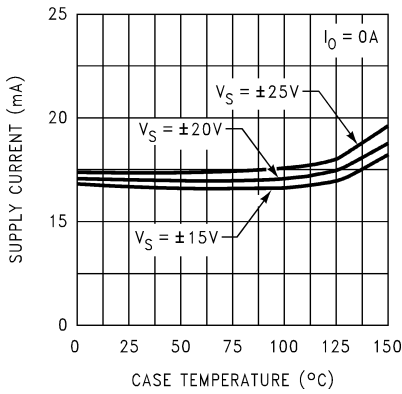

10083542

Standby Current (I_{CC}) vs Standby Pin Voltage

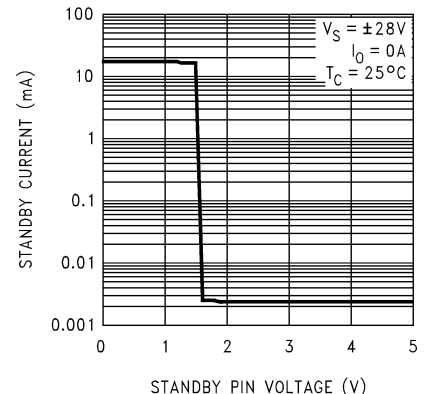

10083543

Supply Current (I_{EE}) vs Standby Pin Voltage

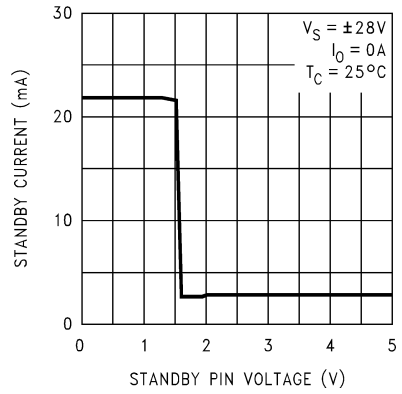

10083544

Input Bias Current vs Case Temperature

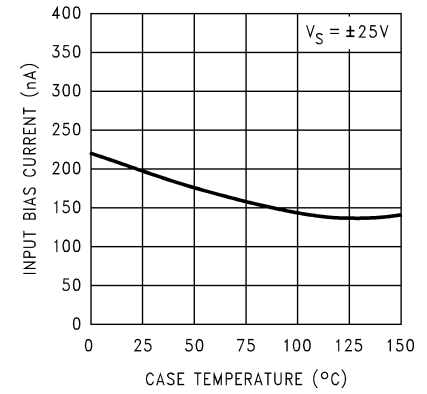

10083545

Application Information

MUTE MODE

By placing a logic-high voltage on the mute pin, the signal going into the amplifiers will be muted. If the mute pin is left floating or connected to a logic-low level, the amplifier will be in a non-muted state. Refer to the **Typical Performance Characteristics** section for curves concerning Mute Attenuation vs Mute Pin Voltage.

STANDBY MODE

The standby mode of the LM4701 allows the user to drastically reduce power consumption when the amplifier is idle. By placing a logic-high voltage on the standby pin, the amplifier will go into Standby Mode. In this mode, the current drawn from the V_{CC} supply is typically less than 10 μA total for both amplifiers. The current drawn from the V_{EE} supply is typically 2.1 mA. Clearly, there is a significant reduction in idle power consumption when using the standby mode. Refer to the **Typical Performance Characteristics** section for curves showing Supply Current vs Standby Pin Voltage for both supplies.

UNDER-VOLTAGE PROTECTION

Upon system power-up, the under-voltage protection circuitry allows the power supplies and their corresponding capacitors to come up close to their full values before turning on the LM4701 such that no DC output spikes occur. Upon turn-off, the output of the LM4701 is brought to ground before the power supplies such that no transients occur at power-down.

OVER-VOLTAGE PROTECTION

The LM4701 contains over-voltage protection circuitry that limits the output current to approximately 3.5 Apk while also providing voltage clamping, though not through internal clamping diodes. The clamping effect is quite the same, however, the output transistors are designed to work alternately by sinking large current spikes.

SPiKe PROTECTION

The LM4701 is protected from instantaneous peak-temperature stressing of the power transistor array. The Safe Operating Area graph in the **Typical Performance Characteristics** section shows the area of device operation where SPiKe Protection Circuitry is not enabled. The waveform to the right of the SOA graph exemplifies how the dynamic protection will cause waveform distortion when enabled.

THERMAL PROTECTION

The LM4701 has a sophisticated thermal protection scheme to prevent long-term thermal stress of the device. When the temperature on the die reaches 165°C, the LM4701 shuts down. It starts operating again when the die temperature drops to about 155°C, but if the temperature again begins to rise, shutdown will occur again at 165°C. Therefore, the device is allowed to heat up to a relatively high temperature if the fault condition is temporary, but a sustained fault will cause the device to cycle in a Schmitt Trigger fashion between the thermal shutdown temperature limits of 165°C and 155°C. This greatly reduces the stress imposed on the IC by thermal cycling, which in turn improves its reliability under sustained fault conditions.

Since the die temperature is directly dependent upon the heat sink used, the heat sink should be chosen such that

thermal shutdown will not be reached during normal operation. Using the best heat sink possible within the cost and space constraints of the system will improve the long-term reliability of any power semiconductor device, as discussed in the **Determining the Correct Heat Sink** Section.

DETERMINING MAXIMUM POWER DISSIPATION

Power dissipation within the integrated circuit package is a very important parameter requiring a thorough understanding if optimum power output is to be obtained. An incorrect maximum power dissipation calculation may result in inadequate heat sinking causing thermal shutdown and thus limiting the output power.

Equation (1) exemplifies the theoretical maximum power dissipation point of each amplifier where V_{CC} is the total supply voltage.

$$P_{DMAX} = V_{CC}^2 / 2\pi^2 R_L \quad (1)$$

Thus by knowing the total supply voltage and rated output load, the maximum power dissipation point can be calculated. Refer to the graphs of Power Dissipation vs Output Power in the **Typical Performance Characteristics** section which show the actual full range of power dissipation not just the maximum theoretical point that results from equation (1).

DETERMINING THE CORRECT HEAT SINK

The choice of a heat sink for a high-power audio amplifier is made entirely to keep the die temperature at a level such that the thermal protection circuitry does not operate under normal circumstances.

The thermal resistance from the die (junction) to the outside air (ambient) is a combination of three thermal resistances, θ_{JC} , θ_{CS} and θ_{SA} . The thermal resistance, θ_{JC} (junction to case), of the LM4701 is 2°C/W. Using Thermalloy Thermacote thermal compound, the thermal resistance, θ_{CS} (case to sink), is about 0.2°C/W. Since convection heat flow (power dissipation) is analogous to current flow, thermal resistance is analogous to electrical resistance, and temperature drops are analogous to voltage drops, the power dissipation out of the LM4701 is equal to the following:

$$P_{DMAX} = (T_{JMAX} - T_{AMB}) / \theta_{JA} \quad (2)$$

where $T_{JMAX} = 150^\circ\text{C}$, T_{AMB} is the system ambient temperature and $\theta_{JA} = \theta_{JC} + \theta_{CS} + \theta_{SA}$.

Once the maximum package power dissipation has been calculated using equation (1), the maximum thermal resistance, θ_{SA} , (in °C/W) for a heat sink can be calculated. This calculation is made using equation (3) which is derived by solving for θ_{SA} in equation (2).

$$\theta_{SA} = [(T_{JMAX} - T_{AMB}) - P_{DMAX}(\theta_{JC} + \theta_{CS})] / P_{DMAX} \quad (3)$$

Again it must be noted that the value of θ_{SA} is dependent upon the system designer's amplifier requirements. If the ambient temperature that the audio amplifier is to be working under is higher than 25°C, then the thermal resistance for the heat sink, given all other things are equal, will need to be smaller.

SUPPLY BYPASSING

The LM4701 has excellent power supply rejection and does not require a regulated supply. However, to improve system performance as well as eliminate possible oscillations, the LM4701 should have its supply leads bypassed with low-inductance capacitors having short leads that are located close to the package terminals. Inadequate power supply bypassing will manifest itself by a low frequency oscillation known as "motorboating" or by high frequency instabilities. These instabilities can be eliminated through multiple by-

Application Information (Continued)

passing utilizing a large tantalum or electrolytic capacitor (10 μF or larger) which is used to absorb low frequency variations and a small ceramic capacitor (0.1 μF) to prevent any high frequency feedback through the power supply lines.

If adequate bypassing is not provided, the current in the supply leads which is a rectified component of the load current may be fed back into internal circuitry. This signal causes distortion at high frequencies requiring that the supplies be bypassed at the package terminals with an electrolytic capacitor of 470 μF or more.

BRIDGED AMPLIFIER APPLICATION

One common power amplifier configuration is shown in *Figure 2* and is referred to as “bridged mode” operation. Bridged mode operation is different from the classical single-ended amplifier configuration where one side of the output load is connected to ground.

A bridge amplifier design has a distinct advantage over the single-ended configuration, as it provides differential drive to the load, thus doubling output swing for a specified supply voltage. Consequently, theoretically four times the output power is possible as compared to a single-ended amplifier under the same conditions. This increase in attainable output power assumes that the amplifier is not current limited or clipped.

A direct consequence of the increased power delivered to the load by a bridge amplifier is an increase in internal power dissipation. For each operational amplifier in a bridge configuration, the internal power dissipation will increase by a factor of two over the single ended dissipation. Since there are two amplifiers used in a bridge configuration, the maximum system power dissipation point will increase by a factor of four over the figure obtained by equation (1).

This value of P_{DMAX} can be used to calculate the correct size heat sink for a bridged amplifier application, assuming that both IC's are mounted on the same heatsink. Since the internal dissipation for a given power supply and load is increased by using bridged-mode, the heatsink's θ_{SA} will have to decrease accordingly as shown by equation (3). Refer to the section, **Determining the Correct Heat Sink**, for a more detailed discussion of proper heat sinking for a given application.

SINGLE-SUPPLY AMPLIFIER APPLICATION

The typical application of the LM4701 is a split supply amplifier. But as shown in *Figure 3*, the LM4701 can also be used in a single power supply configuration. This involves using some external components to create a half-supply bias which is used as the reference for the inputs and outputs. Thus, the signal will swing around half-supply much like it swings around ground in a split-supply application. Along with proper circuit biasing, a few other considerations must be accounted for to take advantage of all of the LM4701 functions.

The LM4701 possesses a mute and standby function with internal logic gates that are half-supply referenced. Thus, to enable either the mute or standby function, the voltage at these pins must be a minimum of 2.5V above half-supply. In single-supply systems, devices such as microprocessors and simple logic circuits used to control the mute and standby functions, are usually referenced to ground, not half-supply. Thus, to use these devices to control the logic circuitry of the LM4701, a “level shifter”, like the one shown

in *Figure 5*, must be employed. A level shifter is not needed in a split-supply configuration since ground is also half-supply.

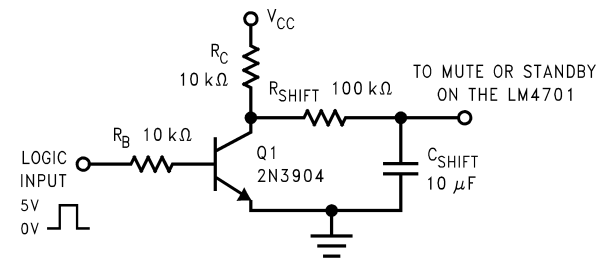

10083509

FIGURE 5. Level Shift Circuit

When the voltage at the Logic Input node is 0V, the 2N3904 is “off” and thus resistor R_C pulls up mute or standby input to the supply. This enables the mute or standby function. When the Logic Input is 5V, the 2N3904 is “on” and consequently, the voltage at the collector is essentially 0V. This will disable the mute or standby function, and thus the amplifier will be in its normal mode of operation. R_{SHIFT} , along with C_{SHIFT} , creates an RC time constant that reduces transients when the mute or standby functions are enabled or disabled. Additionally, R_{SHIFT} limits the current supplied by the internal logic gates of the LM4701 which insures device reliability. Refer to the Mute Mode and Standby Mode sections in the **Application Information** section for a more detailed description of these functions.

CLICKS AND POPS

In the typical application of the LM4701 as a split-supply audio power amplifier, the IC exhibits excellent “click” and “pop” performance when utilizing the mute and standby functions. In addition, the device employs Under-Voltage Protection, which eliminates unwanted power-up and power-down transients. The basis for these functions are a stable and constant half-supply potential. In a split-supply application, ground is the stable half-supply potential. But in a single-supply application, the half-supply needs to charge up just like the supply rail, V_{CC} .

This makes the task of attaining a clickless and popless turn-on more challenging. Any uneven charging of the amplifier inputs will result in output clicks and pops due to the differential input topology of the LM4701.

To achieve a transient free power-up and power-down, the voltage seen at the input terminals should be ideally the same. Such a signal will be common-mode in nature, and will be rejected by the LM4701. In *Figure 3*, the resistor R_{INP} serves to keep the inputs at the same potential by limiting the voltage difference possible between the two nodes. This should significantly reduce any type of turn-on pop, due to an uneven charging of the amplifier inputs. This charging is based upon a specific application loading and thus, the system designer may need to adjust these values for optimum performance.

As shown in *Figure 3*, the resistors labeled R_{BI} help bias up the LM4701 off the half-supply node at the emitter of the 2N3904. But due to the input and output coupling capacitors in the circuit, along with the negative feedback, there are two different values of R_{BI} , namely 10 k Ω and 200 k Ω . These resistors bring up the inputs at the same rate resulting in a popless turn-on. Adjusting these resistors values slightly

Application Information (Continued)

may reduce pops resulting from power supplies that ramp extremely quick or exhibit overshoot during system turn-on.

AUDIO POWER AMPLIFIER DESIGN

Design a 25W/8Ω Audio Amplifier

Given:

Power Output	25 Wrms
Load Impedance	8Ω
Input Level	1 Vrms(max)
Input Impedance	47 kΩ
Bandwidth	20 Hz to 20 kHz ± 0.25 dB

A designer must first determine the power supply requirements in terms of both voltage and current needed to obtain the specified output power. V_{OPEAK} can be determined from equation (4) and I_{OPEAK} from equation (5).

$$V_{OPEAK} = \sqrt{(2 R_L P_O)} \quad (4)$$

$$I_{OPEAK} = \sqrt{(2 P_O)/R_L} \quad (5)$$

To determine the maximum supply voltage, the following conditions must be considered. Add the dropout voltage to the peak output swing V_{OPEAK} , to get the supply rail at a current of I_{OPEAK} . The regulation of the supply determines the unloaded voltage which is usually about 15% higher. The supply voltage will also rise 10% during high line conditions. Therefore the maximum supply voltage is obtained from the following equation:

$$\text{Max Supplies} \approx \pm (V_{OPEAK} + V_{OD}) (1 + \text{Regulation}) \quad (1.1)$$

For 25W of output power into an 8Ω load, the required V_{OPEAK} is 20V. A minimum supply rail of ±25V results from

adding V_{OPEAK} and V_{OD} . With regulation, the maximum supplies are ±31.7V and the required I_{OPEAK} is 2.5A from equation (5). At this point it is a good idea to check the Power Output vs Supply Voltage to ensure that the required output power is obtainable from the device while maintaining low THD+N. In addition, the designer should verify that with the required power supply voltage and load impedance, that the required heatsink value θ_{SA} is feasible given system cost and size constraints. Once the heatsink issues have been addressed, the required gain can be determined from equation (6).

$$A_V \geq \sqrt{(P_O R_L)/(V_{IN})} = V_{ORMS}/V_{INRMS} \quad (6)$$

From equation (6), the minimum A_V is $A_V \geq 14.14$.

By selecting a gain of 21, and with a feedback resistor, $R_F = 20 \text{ k}\Omega$, the value of R_1 follows from equation (7).

$$R_1 = R_F (A_V - 1) \quad (7)$$

Thus with $R_J = 1 \text{ k}\Omega$ a non-inverting gain of 21 will result. Since the desired input impedance was 47 kΩ, a value of 47 kΩ was selected for R_{IN} . The final design step is to address the bandwidth requirements which must be stated as a pair of -3 dB frequency points. Five times away from a -3 dB point is 0.17 dB down from passband response which is better than the required ±0.25 dB specified. This fact results in a low and high frequency pole of 4 Hz and 100 kHz respectively. As stated in the **External Components** section, R_1 in conjunction with C_1 create a high-pass filter.

$$C_1 \geq 1/(2\pi * 1 \text{ k}\Omega * 4 \text{ Hz}) = 39.8 \text{ }\mu\text{F}; \text{ use } 39 \text{ }\mu\text{F}.$$

The high frequency pole is determined by the product of the desired high frequency pole, f_H , and the gain, A_V . With a $A_V = 21$ and $f_H = 100 \text{ kHz}$, the resulting GBWP of 2.1 MHz is less than the minimum GBWP of 5 MHz for the LM4701. This will ensure that the high frequency response of the amplifier will be no worse than 0.17 dB down at 20 kHz which is well within the bandwidth requirements of the design.

Physical Dimensions inches (millimeters) unless otherwise noted

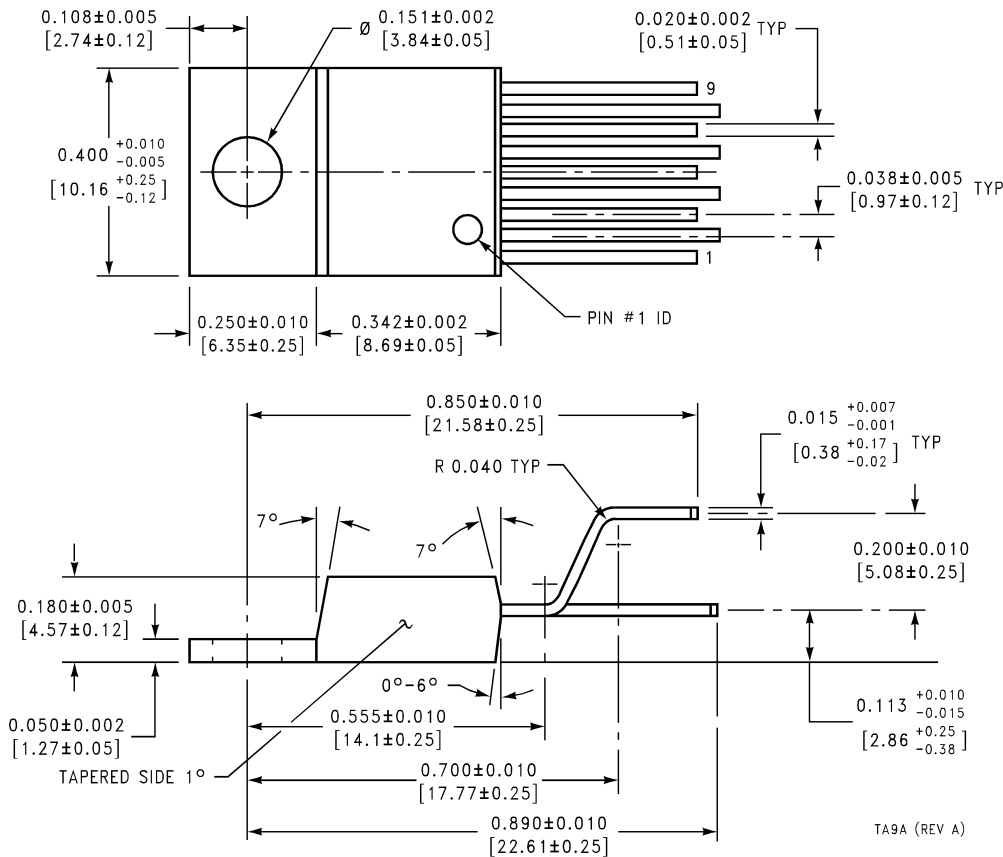

For Staggered Lead Non-Isolated Package
Only a 9-Pin Package
Order Number LM4701T
NS Package Number TA9A

National does not assume any responsibility for use of any circuitry described, no circuit patent licenses are implied and National reserves the right at any time without notice to change said circuitry and specifications.

For the most current product information visit us at www.national.com.

LIFE SUPPORT POLICY

NATIONAL'S PRODUCTS ARE NOT AUTHORIZED FOR USE AS CRITICAL COMPONENTS IN LIFE SUPPORT DEVICES OR SYSTEMS WITHOUT THE EXPRESS WRITTEN APPROVAL OF THE PRESIDENT AND GENERAL COUNSEL OF NATIONAL SEMICONDUCTOR CORPORATION. As used herein:

- Life support devices or systems are devices or systems which, (a) are intended for surgical implant into the body, or (b) support or sustain life, and whose failure to perform when properly used in accordance with instructions for use provided in the labeling, can be reasonably expected to result in a significant injury to the user.
- A critical component is any component of a life support device or system whose failure to perform can be reasonably expected to cause the failure of the life support device or system, or to affect its safety or effectiveness.

BANNED SUBSTANCE COMPLIANCE

National Semiconductor certifies that the products and packing materials meet the provisions of the Customer Products Stewardship Specification (CSP-9-111C2) and the Banned Substances and Materials of Interest Specification (CSP-9-111S2) and contain no "Banned Substances" as defined in CSP-9-111S2.

 National Semiconductor
Americas Customer
Support Center
Email: new.feedback@nsc.com
Tel: 1-800-272-9959

National Semiconductor
Europe Customer Support Center
Fax: +49 (0) 180-530 85 86
Email: europe.support@nsc.com
Deutsch Tel: +49 (0) 69 9508 6208
English Tel: +44 (0) 870 24 0 2171
Français Tel: +33 (0) 1 41 91 8790

National Semiconductor
Asia Pacific Customer
Support Center
Email: ap.support@nsc.com

National Semiconductor
Japan Customer Support Center
Fax: 81-3-5639-7507
Email: jpn.feedback@nsc.com
Tel: 81-3-5639-7560